

Filterdüsen

Filter-Nozzles

Crépines à filtre

Toberas filtrantes

Typ K1 / KR1

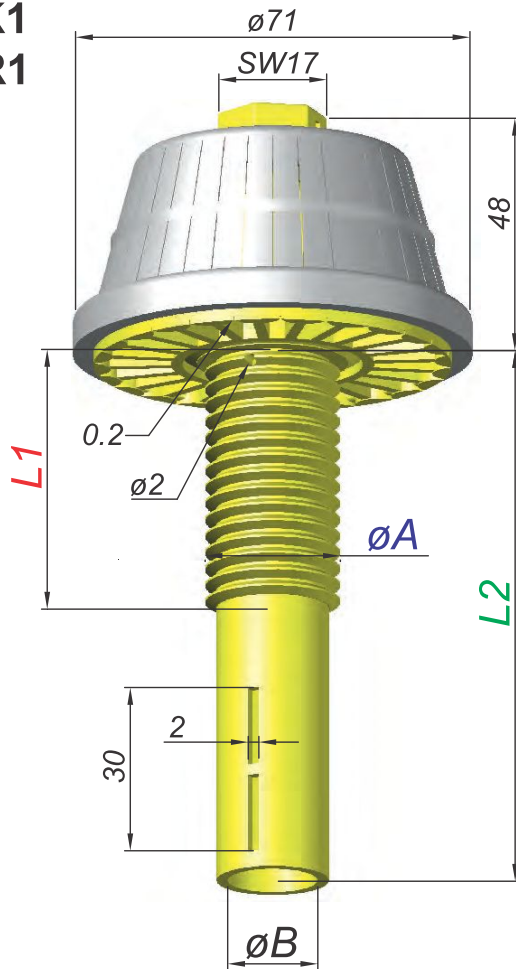



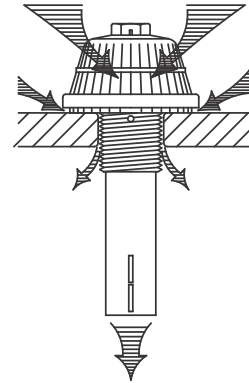



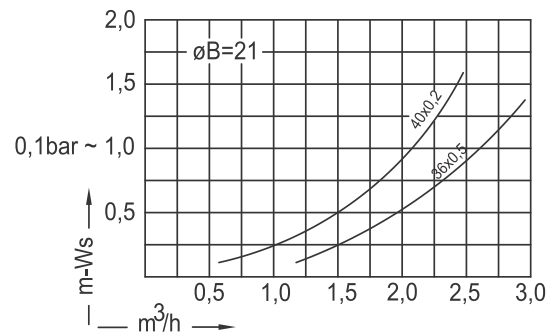
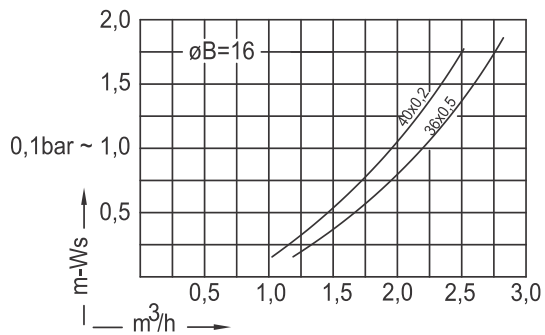
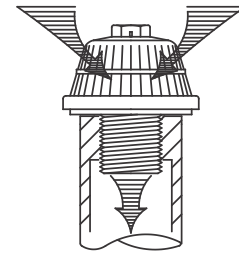



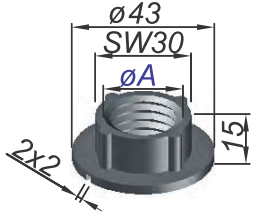

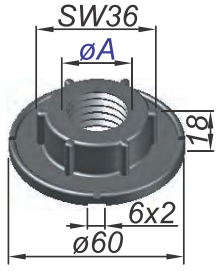
Typ K1

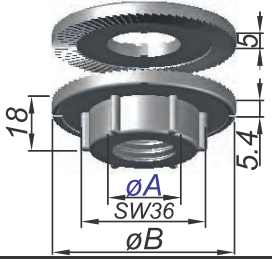

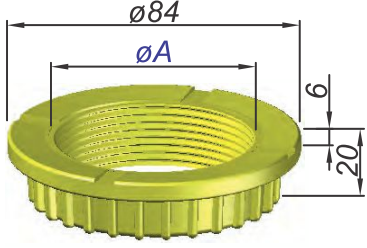
Typ KR1

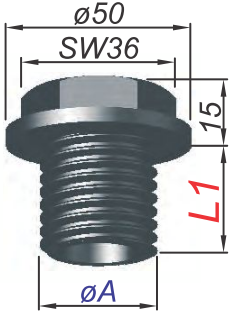

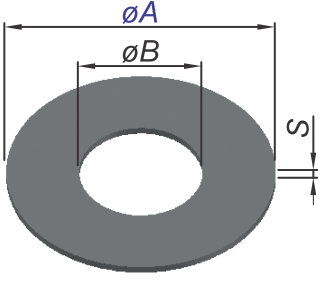
Bestellung Ordering Commande Encargo	Typ Type Type Tipa	Schlitze Slots Fentes Ranuras	Gewinde Thread Filetage Rosca	øA	Gewindelänge Thread length Longueur de filetage Largura de la rosca	Schaft Shaft Longueur de tige Tija	øB
✉	K1 KR1	40x0,2 = 1,95 cm ² 36x0,35 = 2,96 cm ² 20x0,5 = 2,35 cm ² 36x0,5 = 4,23 cm ² 20x0,8 = 3,78 cm ² 36x1,0 = 8,46 cm ² 24x1,5 = 7,05 cm ² 20x2,0 = 9,50 cm ²	G1"	33,25	20	80, 110, 140, 200, 250, 300, 350, ...	21 = 3,4 cm ²
			1½" WW	32	20, 30, 45, +5+5...		
			M30 x 3.5	30	30		
			G3/4"	26,5	20, 30, 45, +5+5...	80, 110, 140, 200, 250, 300, 350, ...	16 = 2,0 cm ²
			1" WW	25,4	20, 45, +5+5...		
			M24	24	25, 45, +5+5...		
			M22 x 1,5	22	45, +5+5...		
			G1/2"	21	15, 20, 40	80, 110, 140, 200, ...	13 = 1,3 cm ²
			M20	20	45, +5+5...		
			G3/8"	16,7	20		

Muttern und Scheiben	Nuts and Washers	Ecrous et joints	Tuerca y Arandela			
Typ MU43 	Bestellung Ordering Commande Encargo	Typ Type Type Tipa	Gewinde Thread Filetage Rosca øA			
		MU43	1"WW M24 M22x1,5 M20			
Typ MU60 	Bestellung Ordering Commande Encargo	Typ Type Type Tipa	Gewinde Thread Filetage Rosca øA			
		MU60	1 1/4" WW 1"WW G 3/4" M24 M22x1,5 M20			
Typ MUZ 	Bestellung Ordering Commande Encargo	Typ Type Type Tipa	Gewinde Thread Filetage Rosca øA	øB		
		MUZ	M24	50		
Typ MU84 	Bestellung Ordering Commande Encargo	Typ Type Type Tipa	Gewinde Thread Filetage Rosca øA			
		MU84	G 2" G 1 1/2"			
Typ SR50 	Bestellung Ordering Commande Encargo	Typ Type Type Tipa	Gewinde Thread Filetage Rosca	øA	L1	
		SR50	1 1/4" WW	32	...mm	
			G 1"	33,25		
			G 3/4"	26,5		
			M24	24		
Typ DP Typ DG 	Bestellung Ordering Commande Encargo	Typ Type Type Tipa	øA	øB	S	Material Material Material
		DP	50	32; 30; 27; 25; 21	2	PP
				32; 25	5	
				32; 30; 25	7	
			70	32; 30; 27; 25; 21	2	
		32; 30; 28		7		
		DG	50	32; 28; 25; 21	2	EPDM (KTW)
	70					
	90					